

Product Information



ETX085x70-Ø12 HL75-A

EAN 4031582330854

Wheel center made of steel, tread made of Polyurethane, casted, precision ball bearing, sealed

Technical Data

Wheel diameter	3.35 in
Tread width	2.76 in
Axle Hole-Ø	0.47 in
Hub length	2.95 in
Temperature	- 4 / + 140 °F
Weight	2.709 lbs
Load capacity (dynamic)	1545 lbs
Load capacity (static)	3085 lbs
Hardness of tread	A 92 Shore
Bearing	6006 2RS



Roll performance	+	+	+	+	+
Movement noise	+	+	+	+	+
Attrition	+	+	+	+	+
Corrosion resistance	+	+	+	+	+

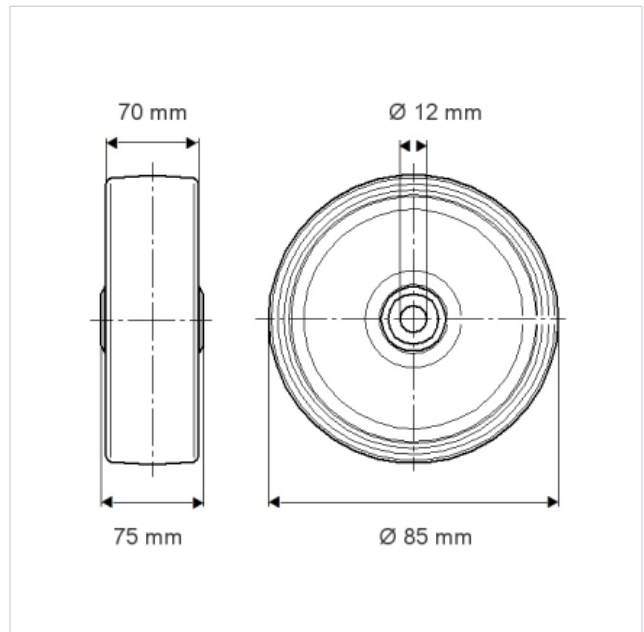

Product Information



ETX085x70-Ø12 HL75-A

EAN 4031582330854

